

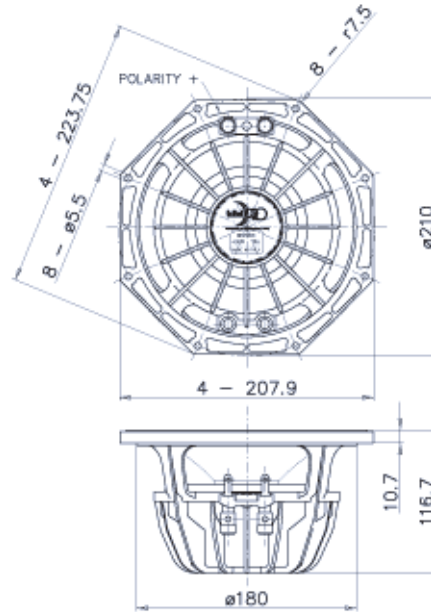

8PR200 Professional Series



NOMINAL SPECIFICATIONS

Nominal Diameter	200 mm (8 in)
Overall Diameter	223.8/203.9 mm (8.81/8.18 in)
Bolt Circle Diameter	210 mm (8.27 in)
Baffle Cutout Diameter	184 mm (7.24 in)
Depth	116.7 mm (4.59 in)
Flange and Gasket Thickness	10.7 mm (0.42 in)
Net Weight	2.1 Kg (4.63 lb)
Shipping Box (Single Carton Box)	235x235x155 mm (9.25x9.25x6.1 in)
Shipping Weight	2.5 Kg (5.51 lb)

ELECTRICAL SPECIFICATION

Minimum Impedance	6.4 Ohm
Nominal Impedance	8 Ohm
Nominal Power Handling *	200 W
Maximum Power Handling **	400 W
Sensitivity (1W/1m)	95 dB
Frequency Range	60÷5000 Hz
Voice Coil Diameter	52 mm (2 in)
Winding Material	Al
Former Material	Glass Fiber
Winding Depth	19.3 mm (0.76 in)
Magnetic Gap Depth	9 mm (0.35 in)
Flux Density	1.15 T

THIELE & SMALL PARAMETERS

Fs	58 Hz
Re	5.1 Ohm
Bl	11.3 N/A
Mms	24 g
Cms	0.31 mm/N
Rms	0.93 Kg/s
Qes	0.39
Qms	8.2
Qts	0.37
Vas	17.6 dm ³ (0.62 ft ³)
Sd	199 cm ² (30.8 in ²)
Xmax ***	8.15 mm
Xdamage ****	13.5 mm
Le	0.55 mH
Mmd	22.4 g
Eta Zero	0.96 %

ORDERING CODES

Push Terminals - 8 Ohm Version	TBA
Faston Terminals - 8 Ohm Version	TBA

NOTES

[Al] demodulation ring for reduced total harmonic distortion

(*) 2 Hours Test According to AES 2-1984 Rev. 2003

(**) Maximum power is defined as 3dB greater than nominal power.

(***) Xmax = [(winding depth - magnetic gap depth) / 2] + (magnetic gap depth / 3)

(****) Maximum excursion before permanent damage

CURVES

